

NowyStyl

eModel 2.0



Let's make your space together





eModel 2.0 line has an GS Safety certificate
| La gamme eModel 2.0 est certifiée GS (certificat de sécurité)

Imagine a perfect world, a perfect place. You have your own aims and dreams, you are looking for the best, you do everything to make your plans come true. You appreciate every day, you make full use of your precious time thanks to new functionalities and solutions. Your ideal world, the perfect place is close at hand...

Imaginez-vous dans un monde parfait, où vous pouvez toujours faire de votre mieux, où vous pouvez tout faire pour réaliser vos projets et accomplir vos rêves. Imaginez un monde avec des fonctionnalités permettant des solutions qui vous font profiter pleinement de votre temps, un monde où tous les jours riment avec bien-être. Ce monde idéal est à portée de main...

FOR THE MOST DEMAND- ING USERS

POUR LES UTILISATEURS
LES PLUS EXIGEANTS

eMood

le 12, 19





DESK





We understand your need to move. This is why eModel 2.0 provides the possibility to work in a sitting and standing position at any time without any effort.

Notre corps n'est pas fait pour rester dans la même position toute la journée. eModel 2.0 a été conçu pour nous permettre de travailler debout ou assis, à tout moment et sans effort.





DESK EXTENSIONS

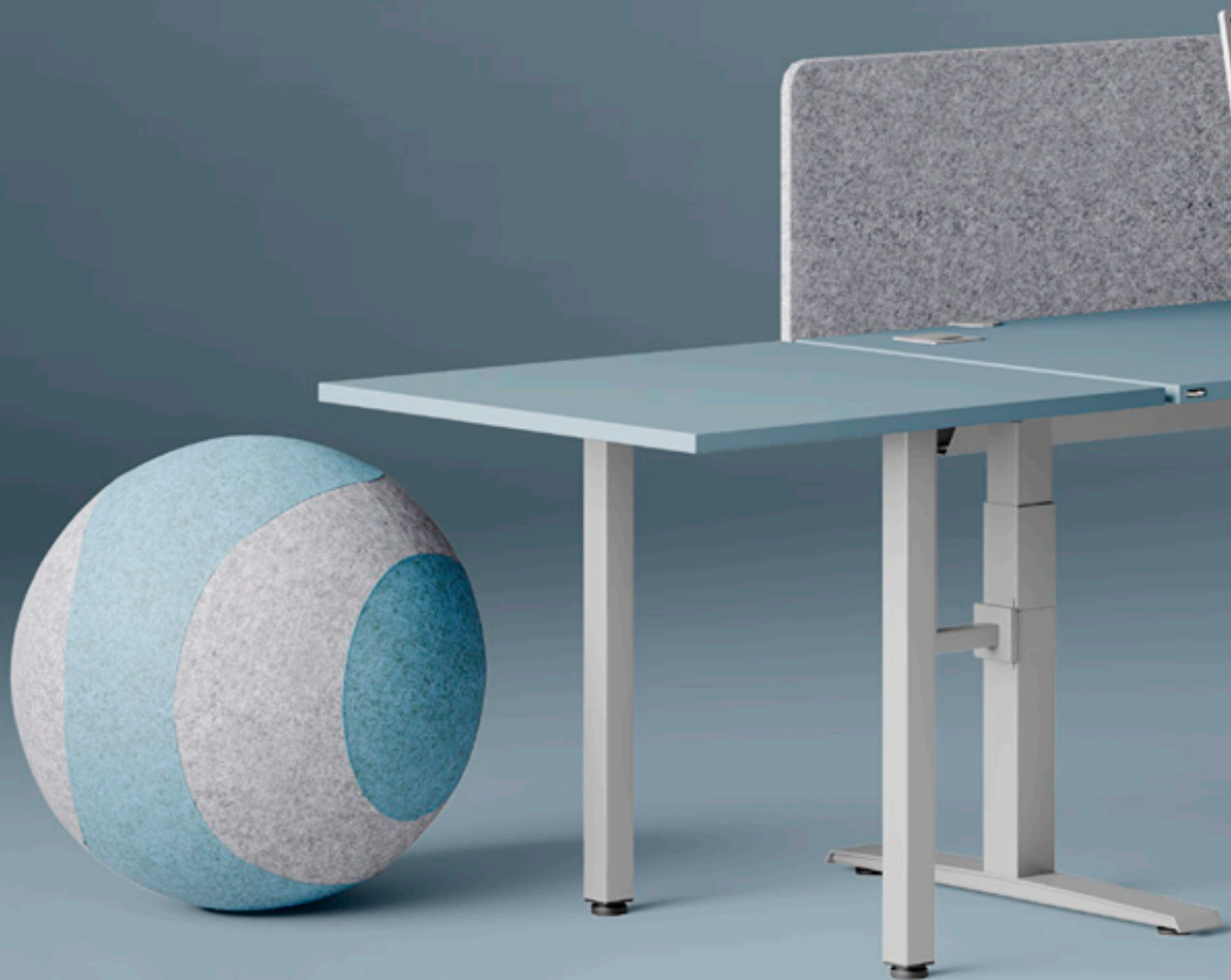

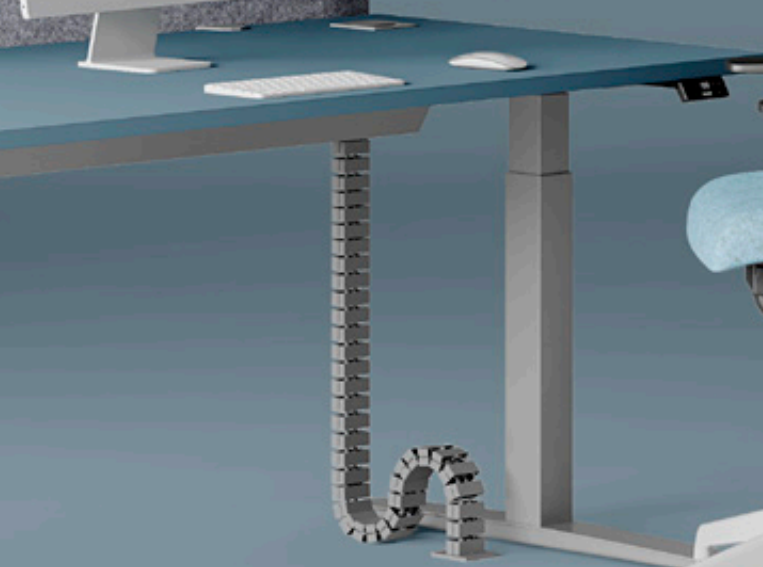

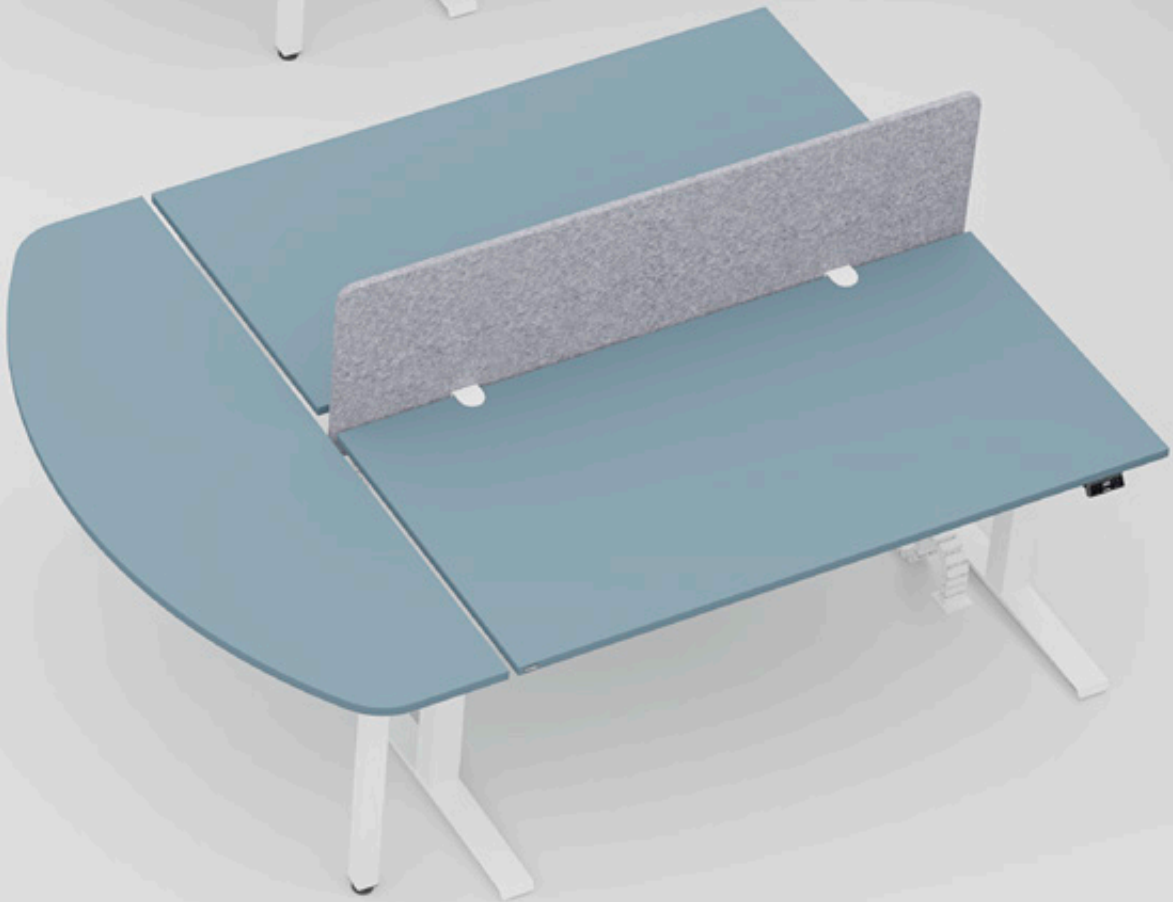
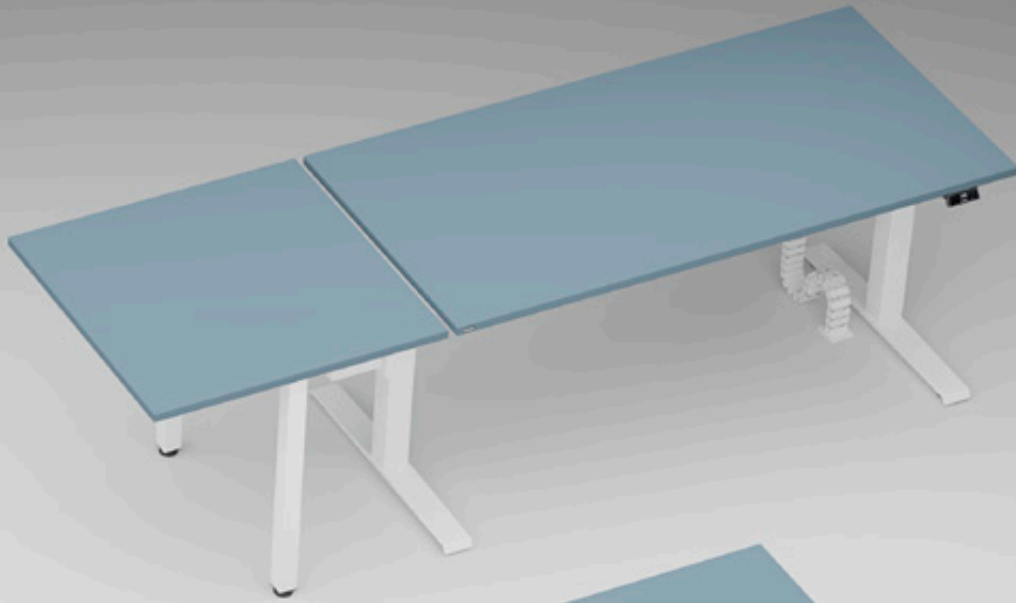

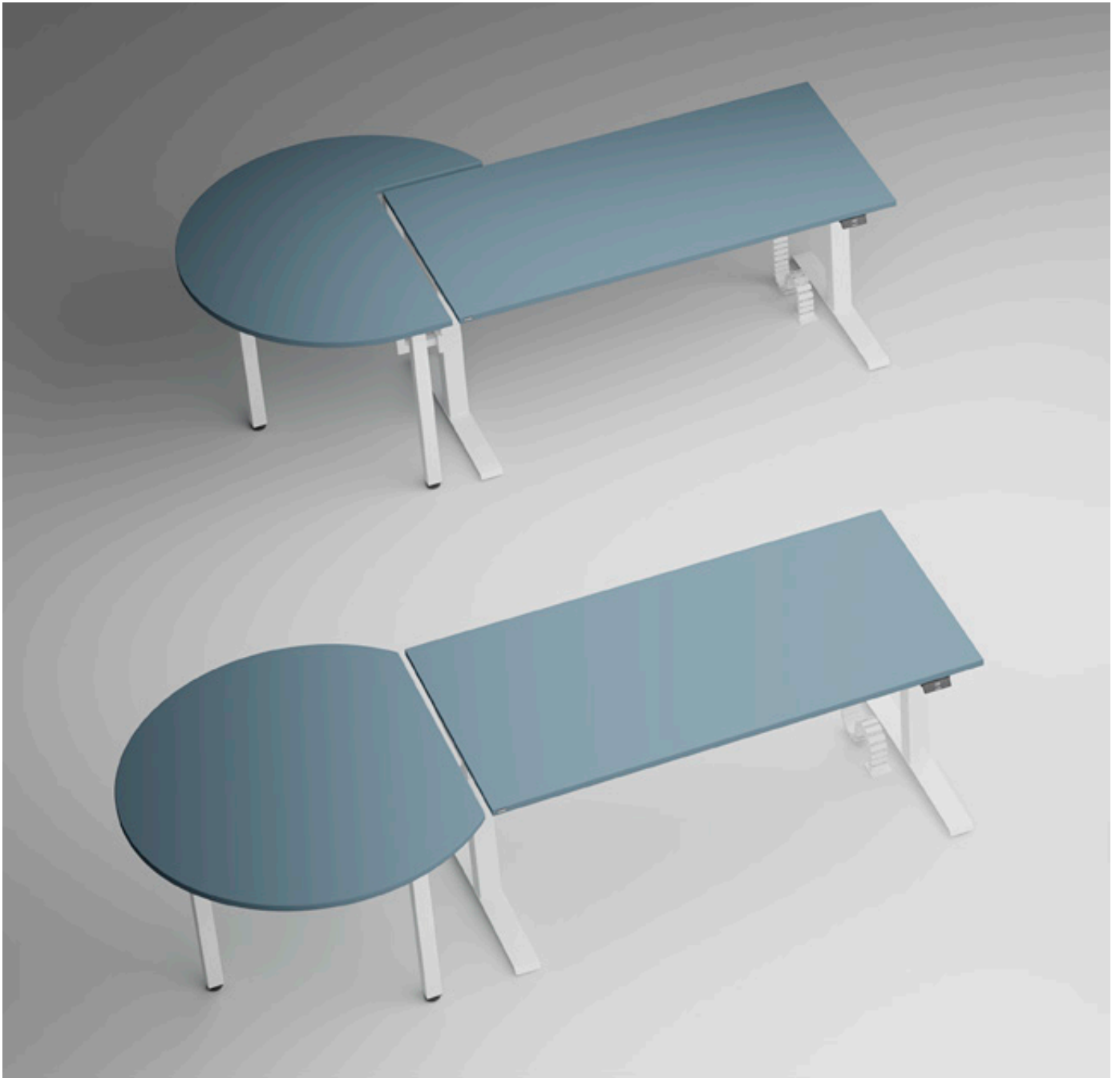

Desk extensions are applicable to all desks on T-leg base. Their height is fixed (740 mm) or manually adjusted in range of 740–860 mm. Such solution provides additional surface which makes short meetings more comfortable for both co-workers.

Pour plus de confort pendant le travail et les réunions spontanées, le plateau du bureau peut être agrandi. Les plans retour sont disponibles pour tous les bureaux avec un piètement de type T. Ils peuvent avoir une hauteur fixe (740 mm) ou réglable manuellement, sur une amplitude de 740-860 mm.

WORKBENCH





You want to be in contact with your team, and at the same time, you want to have your own space that will give you comfort and allow you to perform tasks individually. eModel 2.0 workbench will provide you with an ergonomic place by staying in touch with colleagues.

Vous avez besoin d'être en contact avec votre équipe. Dans le même temps, il vous faut votre propre espace qui vous apportera le confort nécessaire pour rester efficace. Le bench eModel 2.0 vous offrira cet espace de travail ergonomique tout en vous permettant de rester en contact avec les membres de votre équipe.





CONFERENCE TABLE





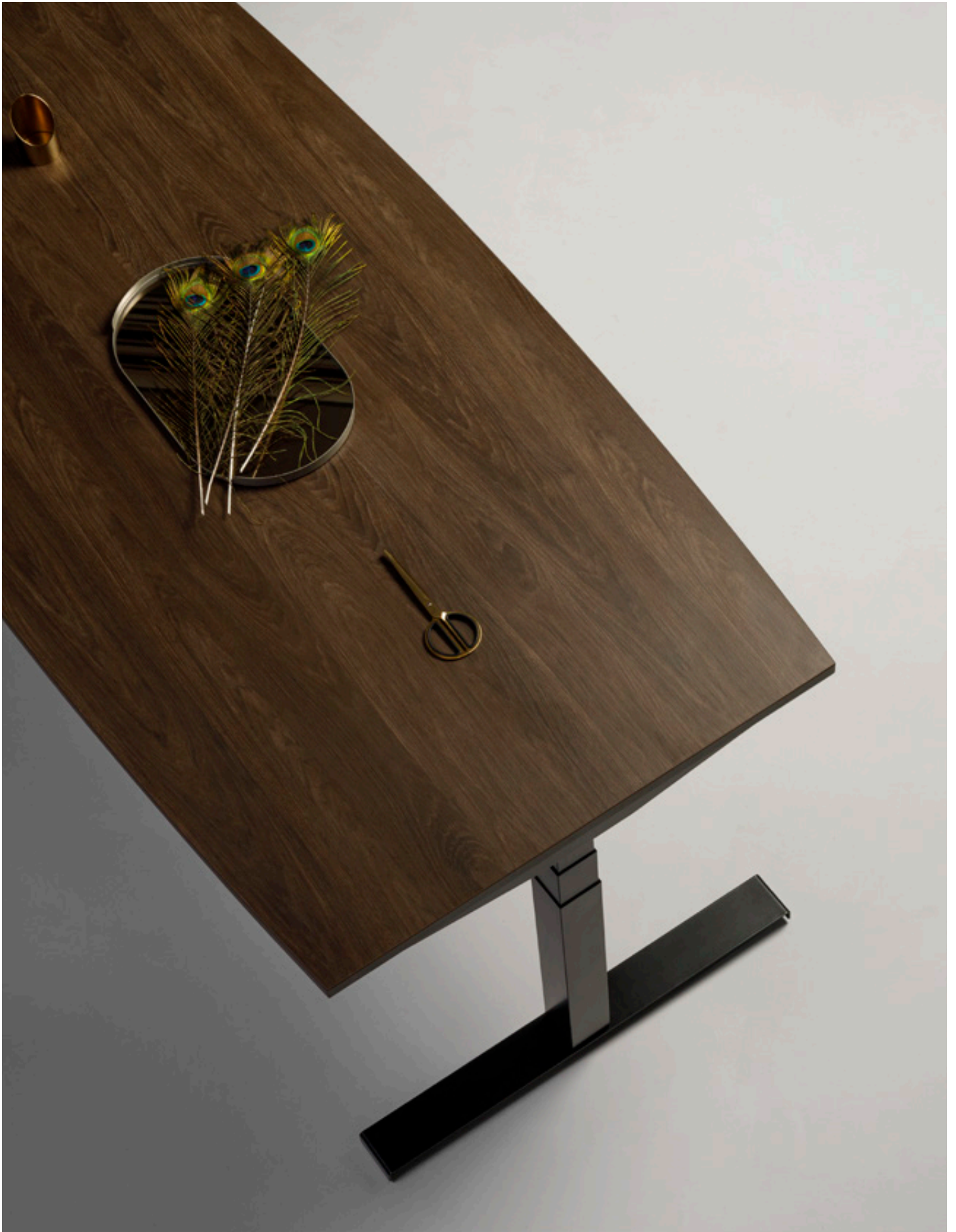

Meetings can steal your precious time. Whenever you need quick consultations in a group the height adjustment conference table can offer you place for short informal standing meeting but also a formal meeting which requires a comfortable seating position for a longer time.

La préparation de différents types de réunions peut nous faire perdre beaucoup de temps. Une table de réunion réglable en hauteur est la solution idéale pour les consultations rapides informelles de courte durée, mais aussi pour une réunion formelle qui nécessite une position assise et confortable pour une durée plus longue.



DESIGN IS
NOT JUST
WHAT IT
LOOKS
LIKE.
DESIGN
IS HOW IT
WORKS.

— STEVE JOBS

« LE DESIGN CE N'EST PAS
UNIQUEMENT L'ASPECT. LE DESIGN
C'EST COMMENT CELA MARCHE. »

— STEVE JOBS

Upper fully upholstered, front panel for desks with the possibility of driving pins
| Écran de séparation frontal, entièrement tapissé, pour bureaux, avec possibilité de punaiser





Control panel: up&down button

| Panneau de commande: bouton de réglage haut/bas, par défaut



Control panel with display and memory function

| Panneau de commande avec affichage et fonction de mémoire



Height adjustment by crank for desks and workbenches
| Réglage de la hauteur à l'aide d'une manivelle



Horizontal wire trunking for sliding table top in desks and workbenches

Goulotte horizontale pour plateaux coulissants des bureaux et benches





Vertical wire trunking, flexible modular with magnet
fixed to table top or horizontal wire trunking

Goutte verticale, flexible et modulaire, avec aimant fixé
au plateau ou à la goulotte horizontale



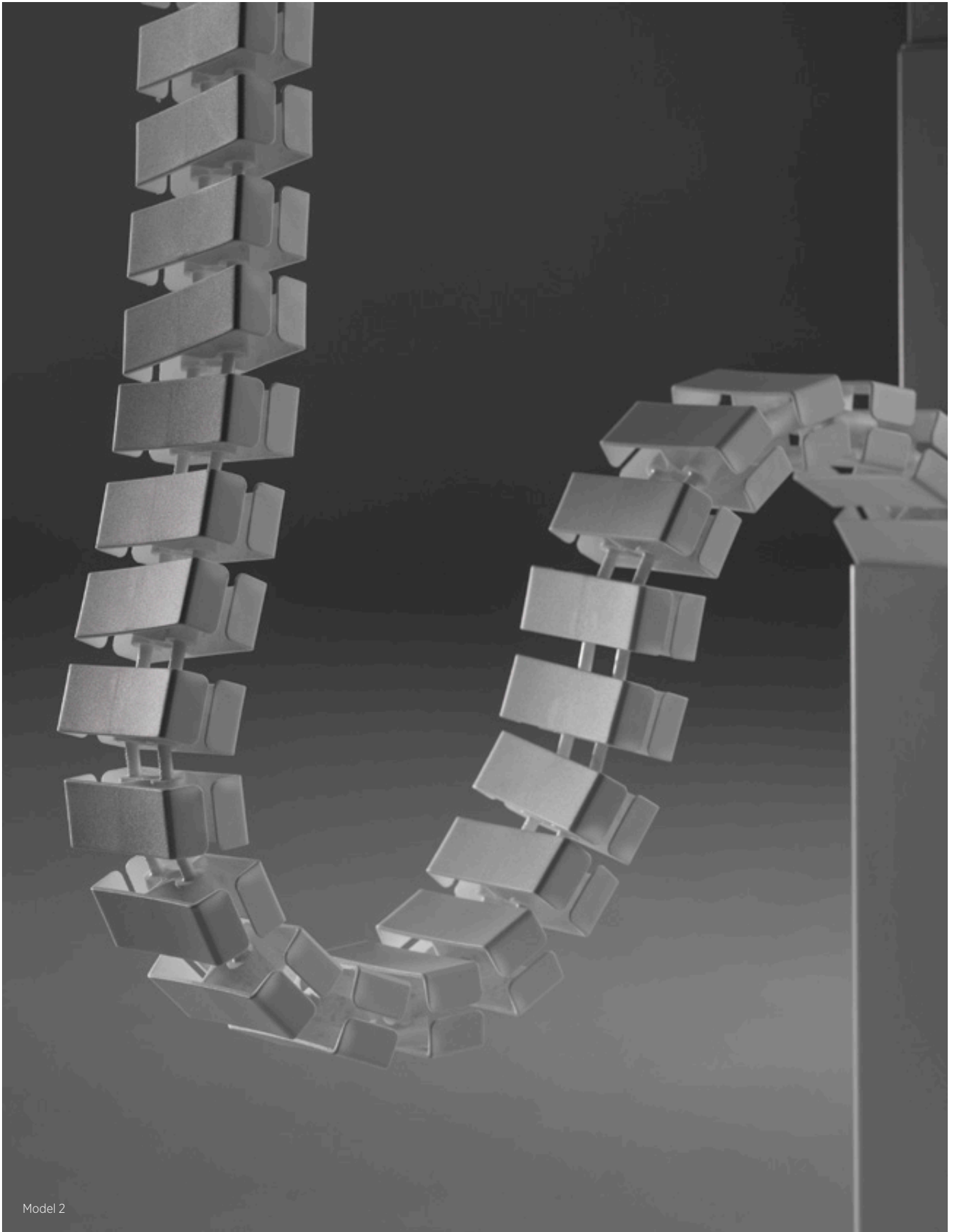

Model 2





Cable cover for desks and workbenches
| Cache-câbles pour bureaux et benches

Electric height adjustment

Réglage électrique de la hauteur



3 segments in the column
| 3 segments par colonne



Load capacity per tabletop - 100 kg
| Charge maximale du plateau - 100 kg



Each column is equipped with a drive
| Chaque colonne est équipée d'un système d'entraînement



AC alternating current drive power supply
| Système d'entraînement : alimentation par courant alternatif



Anti-Collision function (with external gyro sensor) - while moving part of the desk (table top) hits an obstacle, table top stops and reverses to safe position. Function available as standard.
| Fonctionnalité d'anticollision (avec capteur gyroscopique externe) : lorsqu'une partie du bureau en mouvement (plateau) rencontre un obstacle, le plateau s'arrête et se replace en position de sécurité. Cette fonction est disponible en modèle standard.



*Height adjustment for desks, workbenches and conference tables | Réglage de la hauteur pour bureaux, bencs et tables de réunion

Manual height adjustment with crank

Réglage manuel de la hauteur à l'aide d'une manivelle



2 segments in the column
| 2 segments par colonne



Load capacity per tabletop – 75 kg
| Charge maximale du plateau – 75 kg



*Height adjustment range for desks and workbenches | Réglage de la hauteur pour bureaux et banchs

Fixed height

Hauteur fixe



One segment column
| Colonne simple



*Fixed height applies to desks only | Hauteur fixe s'applique uniquement aux bureaux



Foot EM3
| Pied EM3

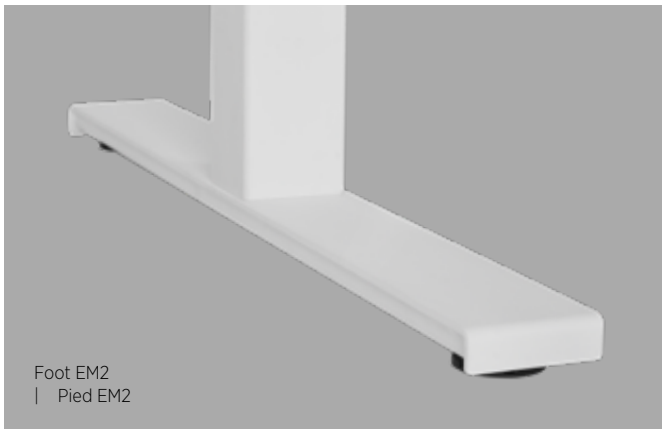

Foot EM2
| Pied EM2



EM2 and EM3 are the foot types available for all desks and conference tables on T-leg base.

EM2 et EM3 sont les types de pied disponibles pour tous les bureaux et tables de réunion avec piètement « T »

Upper fully upholstered panel for workbenches
| Écran de séparation frontal entièrement tapissé pour bench

Workbench - H-legs base with three-segment angular columns
| Poste bench avec piètement « H » à triples colonnes angulaires

1



1
Shared horizontal wire trunking
| Goulotte horizontale partagée



NEVER
ASSUME
THAT
LOUD IS
STRONG,
AND
QUIET IS
WEAK



Noise
| Bruit

<45 dB





SMOOTH MOVE- MENT



38 mm/s

Speed
| Vitesse

Fixed and sliding table tops for desks

Plans fixes ou coulissants pour bureaux

Rectangular
| Rectangulaires

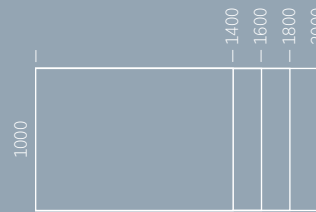
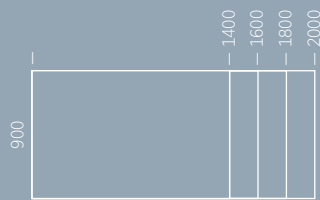
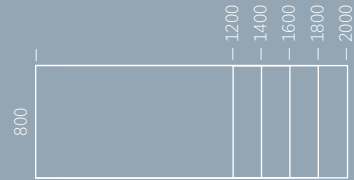
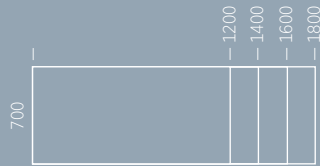

Double wave
| Double vague

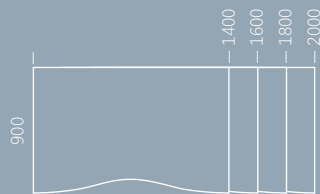

Fixed table tops for desks

Plans fixes pour bureaux

L-shape left / right
| Compact

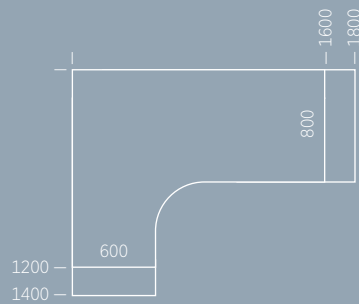

Fixed table tops for conference tables

Plans fixes pour tables de réunion

Barrel-shape table top
| Plan « tonneau »

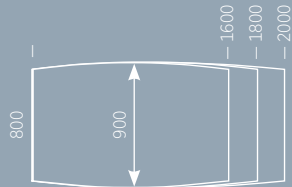

Fixed and sliding table tops for workbenches

Plans fixes ou coulissants pour benches

Rectangular
| Rectangulaires

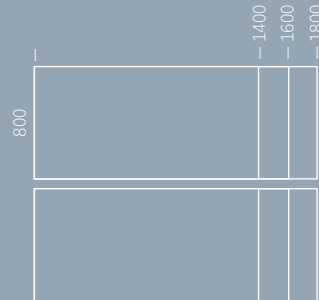
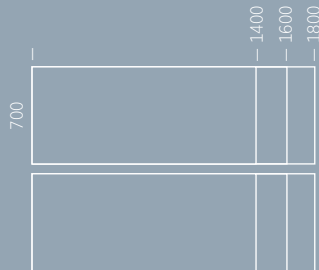

eModel 2.0 line has an GS Safety certificate

| La gamme eModel 2.0 est certifiée GS (certificat de sécurité)

Desk extensions

Plans retour pour bureaux

I-LEG SQ
800 × 800 | 900 × 900

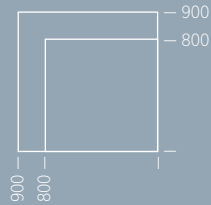

I-LEG RDA
DI 1200 mm / side 800 mm

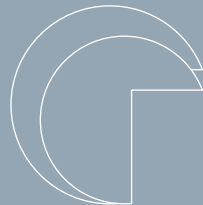

DI 1300 mm / side 900 mm

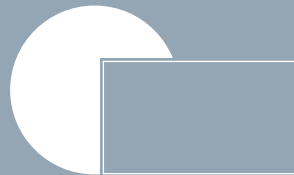

I-LEG RDB
DI 1200 mm / side 800 mm

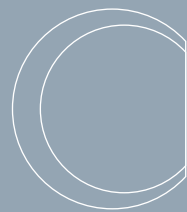

DI 1300 mm / side 900 mm

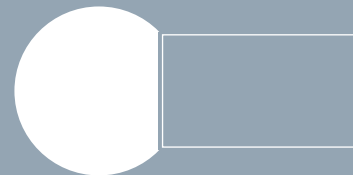

I-LEG DS
600 × 1625 / 1690 / 1825 / 1890 mm

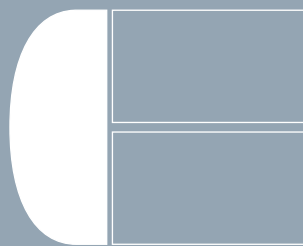

Control panel

Panneau de commande

Up&down button

| Bouton de réglage haut / bas



Display and memory function

| Affichage et fonction de mémoire



Speed 38 mm/s
| Vitesse 38 mm/s



<45 dB

Noise <45 dB
| Bruit <45 dB



Load capacity per table top – 20 kg
| Charge maximale du plateau : 20 kg



AC alternating current drive power supply
| Alimentation en courant alternatif



Anti-Collision function (with external gyro sensor) – while moving part of the desk (table top) hits an obstacle, table top stops and reverses to safe position. Function available as standard.
| Système anticollision (avec un capteur gyroscopique externe) : lorsque le plateau du bureau (l'élément mobile) entre en contact avec un obstacle, le plateau s'arrête automatiquement et s'éloigne à une distance de sécurité.

eMood

le 12.0
MINI

eModel 2.0 MINI offers many functions in a small form. The simple design and mobility of the desk allow you to quickly adjust not only to the style of work, but also to space. Do you work in an agile style? Or maybe at home? Thanks to the electric height adjustment, the eModel 2.0 MINI will stand up to any task, taking care of your health and ensuring the comfort of work.

eModel 2.0 MINI, c'est un petit gabarit contenant plusieurs fonctionnalités. Le design épuré et la mobilité de ce bureau permettent de l'adapter non seulement au style de travail, mais également au type de la pièce. Vous travaillez de manière dynamique? Ou bien à la maison? Grâce au réglage électrique de la hauteur, eModel 2.0 MINI sera à la hauteur de toutes les tâches: il assurera votre bonne santé et confort pendant le travail.







eModel 2.0 MINI desk on EM4 base

Bureau eModel 2.0 MINI sur piètement EM4



eModel 2.0 MINI desk on EM5 base

Bureau eModel 2.0 MINI sur piètement EM5





Fixed table tops

Plateaux fixes

Rectangular
| Rectangulaire



Rounded on both sides
| Rectangulaire aux angles arrondis

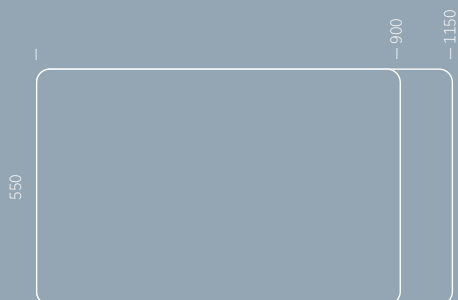

Desk base

Piètements de bureaux

One-column four star base EM4 on glides or castors
| Piètement EM4 à une seule colonne et à quatre branches avec de patins réglables ou roulettes



Height adjustment:
640–1100 mm base on glides
710–1170 mm base on castors
| Course de réglage en hauteur :
640–1100 mm piètement avec de patins
710–1170 mm piètement avec de roulettes

One-column plate base EM5
| Piètement EM5 sur une colonne, avec embase

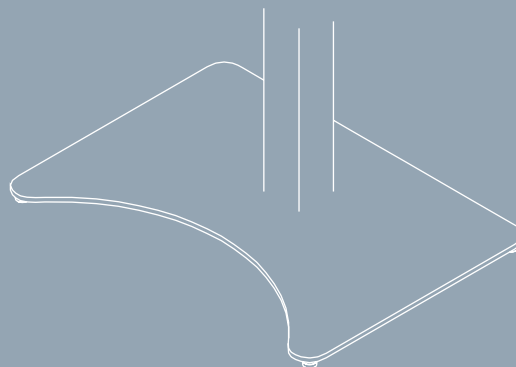

Height adjustment 620–1080 mm
| Zakres regulacji wysokości
620–1080 mm

Control panel

Panneau de commande

Up&down button
| Bouton de réglage haut / bas



Display and memory function
| Affichage et fonction de mémoire



Speed 38 mm/s
| Vitesse 38 mm/s



<45 dB

Noise <45 dB
| Bruit <45 dB



Load capacity per table top - 20kg
| Charge maximale du plateau : 20 kg



AC alternating current drive power supply
| Alimentation en courant alternatif



Anti-Collision function (with external gyro sensor) - while moving part of the desk (table top) hits an obstacle, table top stops and reverses to safe position. Function available as standard.
| Système anticollision (avec un capteur gyroscopique externe) : lorsque le plateau du bureau (l'élément mobile) entre en contact avec un obstacle, le plateau s'arrête automatiquement et s'éloigne à une distance de sécurité.

Angular metal panel

Panneaux séparation tubulaire
métallique d'angle pour bureau MINI

Left or right version
| Version droite et gauche

Tool free assembly to the table top edge
| Facile à assembler - se pousse sur le bord du plateau

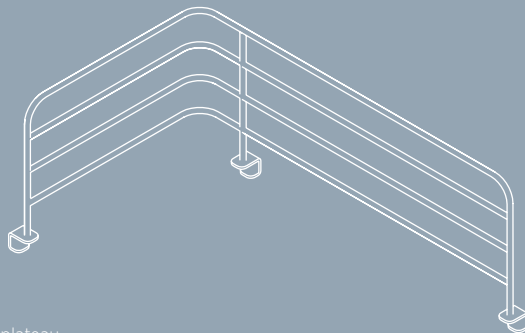





© Copyright 2022 Nowy Styl sp. z o.o.

Nowy Styl sp. z o.o. reserves the right to change the constructional features and finishes of products.

| Nowy Styl sp. z o.o. se réserve le droit de modifier les caractéristiques de construction et les finitions de ses produits.

Note: Colours and patterns illustrated here may vary from the originals.

| Attention : Les coloris réels peuvent légèrement différer des coloris présents dans ce document.

Presented products available in accordance with the market offer.

| La disponibilité de produits selon l'offre du marché correspondant.

Publications of Nowy Styl sp. z o.o.

Brands and trademarks used herein are the property of NSG TM sp. z o.o.

